



**COMMONWEALTH OF PENNSYLVANIA
DEPARTMENT OF ENVIRONMENTAL PROTECTION
AIR QUALITY PROGRAM**

STATE ONLY SYNTHETIC MINOR OPERATING PERMIT

Issue Date: October 21, 2022

Effective Date: October 21, 2022

Expiration Date: October 20, 2027

In accordance with the provisions of the Air Pollution Control Act, the Act of January 8, 1960, P.L. 2119, as amended, and 25 Pa. Code Chapter 127, the Owner, [and Operator if noted] (hereinafter referred to as permittee) identified below is authorized by the Department of Environmental Protection (Department) to operate the air emission source(s) more fully described in this permit. This Facility is subject to all terms and conditions specified in this permit. Nothing in this permit relieves the permittee from its obligations to comply with all applicable Federal, State and Local laws and regulations.

The regulatory or statutory authority for each permit condition is set forth in brackets. All terms and conditions in this permit are federally enforceable unless otherwise designated.

State Only Permit No: 49-00002

Synthetic Minor

Federal Tax Id - Plant Code: 47-0834156-1

Owner Information

Name: CONAGRA FOODS INC
Mailing Address: 30 MARR ST
MILTON, PA 17847-1519

Plant Information

Plant: CONAGRA BRANDS/MILTON PLT
Location: 49 Northumberland County 49805 Milton Borough
SIC Code: 2032 Manufacturing - Canned Specialties

Responsible Official

Name: WILLIAM SEIBERT
Title: OPERATIONS MANAGER
Phone: (570) 428 - 5304 Email: bill.seibert@conagra.com

Permit Contact Person

Name: WILLIAM SEIBERT
Title: OPERATIONS MANAGER
Phone: (570) 428 - 5304 Email: bill.seibert@conagra.com

[Signature] _____

MUHAMMAD Q. ZAMAN, ENVIRONMENTAL PROGRAM MANAGER, NORTHCENTRAL REGION



SECTION A. Table of Contents

Section A. Facility/Source Identification

Table of Contents
Site Inventory List

Section B. General State Only Requirements

- #001 Definitions.
- #002 Operating Permit Duration.
- #003 Permit Renewal.
- #004 Operating Permit Fees under Subchapter I.
- #005 Transfer of Operating Permits.
- #006 Inspection and Entry.
- #007 Compliance Requirements.
- #008 Need to Halt or Reduce Activity Not a Defense.
- #009 Duty to Provide Information.
- #010 Revising an Operating Permit for Cause.
- #011 Operating Permit Modifications
- #012 Severability Clause.
- #013 De Minimis Emission Increases.
- #014 Operational Flexibility.
- #015 Reactivation
- #016 Health Risk-based Emission Standards and Operating Practice Requirements.
- #017 Circumvention.
- #018 Reporting Requirements.
- #019 Sampling, Testing and Monitoring Procedures.
- #020 Recordkeeping.
- #021 Property Rights.
- #022 Alternative Operating Scenarios.
- #023 Reporting
- #024 Report Format

Section C. Site Level State Only Requirements

- C-I: Restrictions
- C-II: Testing Requirements
- C-III: Monitoring Requirements
- C-IV: Recordkeeping Requirements
- C-V: Reporting Requirements
- C-VI: Work Practice Standards
- C-VII: Additional Requirements
- C-VIII: Compliance Certification
- C-IX: Compliance Schedule

Section D. Source Level State Only Requirements

- D-I: Restrictions
- D-II: Testing Requirements
- D-III: Monitoring Requirements
- D-IV: Recordkeeping Requirements
- D-V: Reporting Requirements
- D-VI: Work Practice Standards
- D-VII: Additional Requirements

Note: These same sub-sections are repeated for each source!

Section E. Source Group Restrictions

- E-I: Restrictions



SECTION A. Table of Contents

- E-II: Testing Requirements
- E-III: Monitoring Requirements
- E-IV: Recordkeeping Requirements
- E-V: Reporting Requirements
- E-VI: Work Practice Standards
- E-VII: Additional Requirements

Section F. Alternative Operating Scenario(s)

- F-I: Restrictions
- F-II: Testing Requirements
- F-III: Monitoring Requirements
- F-IV: Recordkeeping Requirements
- F-V: Reporting Requirements
- F-VI: Work Practice Standards
- F-VII: Additional Requirements

Section G. Emission Restriction Summary

Section H. Miscellaneous

**SECTION A. Site Inventory List**

Source ID	Source Name	Capacity/Throughput	Fuel/Material
031	4 BOILERS		
036	BOILER 6	108.000 MMBTU/HR	
		104.200 MCF/HR	Natural Gas
039	BOILER 7	92.000 MMBTU/HR	
		90.196 MCF/HR	Natural Gas
040	BOILER 8	96.800 MMBTU/HR	
043	37 COMBUSTION SOURCES		
044	7 AIR MAKEUP UNITS		
P124	SPAGHETTI EXTRUSION HOPPER 2		
P131	WASTEWATER TREATMENT PLANT		
P141	SIX STORAGE SILOS		
P145	COLD CLEANING MACHINES		
P148	DIESEL FIRE PUMP		
C031	MULTICLONES		
C124B	MAC BAGHOUSE		
C141A	HARD WHEAT SILO 1 COLLECTOR		
C141B	HARD WHEAT SILO 2 COLLECTOR		
C141C	HARD WHEAT SILO 3 COLLECTOR		
C141D	HARD WHEAT SILO 4 COLLECTOR		
C141E	SEMOLINA SILO 1 COLLECTOR		
C141F	SEMOLINA SILO 2 COLLECTOR		
FM03	NATURAL GAS LINE		
FM04	#2 OIL		
S036	BOILER 6 STACK		
S040	BOILER 8 STACK		
S043	SMALL COMBUSTION SOURCE STACKS		
S044	COMBUSTION STACKS		
S05	BOILER 7 STACK		
S124B	COLLECTOR STACK		
S141A	HARD WHEAT SILO 1 STACK		
S141B	HARD WHEAT SILO 2 STACK		
S141C	HARD WHEAT SILO 3 STACK		
S141D	HARD WHEAT SILO 4 STACK		
S141E	SEMOLINA SILO 1 STACK		
S141F	SEMOLINA SILO 2 STACK		
S148	FIRE PUMP STACK		
Z131	WASTEWTR PLT FUG EMISS		
Z145	CLEANING MACHINE EMISSIONS		

PERMIT MAPS



PERMIT MAPS

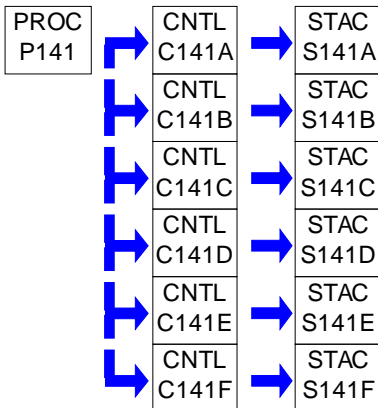
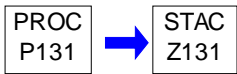
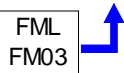
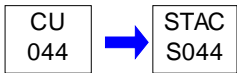
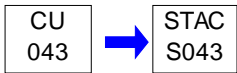
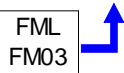
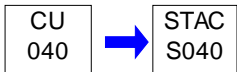
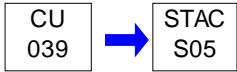
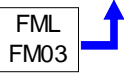
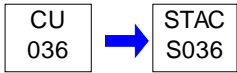



PERMIT MAPS

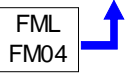
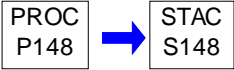
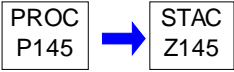

**SECTION B. General State Only Requirements****#001 [25 Pa. Code § 121.1]****Definitions.**

Words and terms that are not otherwise defined in this permit shall have the meanings set forth in Section 3 of the Air Pollution Control Act (35 P.S. § 4003) and in 25 Pa. Code § 121.1.

#002 [25 Pa. Code § 127.446]**Operating Permit Duration.**

- (a) This operating permit is issued for a fixed term of five (5) years and shall expire on the date specified on Page 1 of this permit.
- (b) The terms and conditions of the expired permit shall automatically continue pending issuance of a new operating permit, provided the permittee has submitted a timely and complete application and paid applicable fees required under 25 Pa. Code Chapter 127, Subchapter I and the Department is unable, through no fault of the permittee, to issue or deny a new permit before the expiration of the previous permit.

#003 [25 Pa. Code §§ 127.412, 127.413, 127.414, 127.446 & 127.703(b)]**Permit Renewal.**

- (a) The permittee shall submit a timely and complete application for renewal of the operating permit to the appropriate Regional Air Program Manager. The application for renewal of the operating permit shall be submitted at least six (6) months and not more than 18 months before the expiration date of this permit.
- (b) The application for permit renewal shall include the current permit number, a description of any permit revisions that occurred during the permit term, and any applicable requirements that were promulgated and not incorporated into the permit during the permit term. An application is complete if it contains sufficient information to begin processing the application, has the applicable sections completed and has been signed by a responsible official.
- (c) The permittee shall submit with the renewal application a fee for the processing of the application as specified in 25 Pa. Code § 127.703(b). The fees shall be made payable to "The Commonwealth of Pennsylvania Clean Air Fund" and submitted with the fee form to the respective regional office.
- (d) The renewal application shall also include submission of proof that the local municipality and county, in which the facility is located, have been notified in accordance with 25 Pa. Code § 127.413.
- (e) The application for renewal of the operating permit shall also include submission of supplemental compliance review forms in accordance with the requirements of 25 Pa. Code § 127.412(b) and § 127.412(j).
- (f) The permittee, upon becoming aware that any relevant facts were omitted or incorrect information was submitted in the permit application, shall promptly submit such supplementary facts or corrected information as necessary to address any requirements that become applicable to the source after the permittee submits a complete application, but prior to the date the Department takes action on the permit application.

#004 [25 Pa. Code § 127.703]**Operating Permit Fees under Subchapter I.**

- (a) The permittee shall pay the annual operating permit maintenance fee according to the following fee schedule in either paragraph (1) or (2) in accordance with 25 Pa. Code § 127.703(d) on or before December 31 of each year for the next calendar year.
- (1) For a synthetic minor facility, a fee equal to:
- (i) Four thousand dollars (\$4,000) for calendar years 2021—2025.
 - (ii) Five thousand dollars (\$5,000) for calendar years 2026—2030.
 - (iii) Six thousand three hundred dollars (\$6,300) for the calendar years beginning with 2031.

**SECTION B. General State Only Requirements**

(2) For a facility that is not a synthetic minor, a fee equal to:

- (i) Two thousand dollars (\$2,000) for calendar years 2021—2025.
- (ii) Two thousand five hundred dollars (\$2,500) for calendar years 2026—2030.
- (iii) Three thousand one hundred dollars (\$3,100) for the calendar years beginning with 2031.

(b) The applicable fees shall be made payable to "The Commonwealth of Pennsylvania Clean Air Fund" with the permit number clearly indicated and submitted to the respective regional office.

#005 [25 Pa. Code §§ 127.450 (a)(4) and 127.464]**Transfer of Operating Permits.**

(a) This operating permit may not be transferred to another person, except in cases of transfer-of-ownership that are documented and approved by the Department.

(b) In accordance with 25 Pa. Code § 127.450(a)(4), a change in ownership of the source shall be treated as an administrative amendment if the Department determines that no other change in the permit is required and a written agreement has been submitted to the Department identifying the specific date of the transfer of permit responsibility, coverage and liability between the current and the new permittee and a compliance review form has been submitted to, and the permit transfer has been approved by, the Department.

(c) This operating permit is valid only for those specific sources and the specific source locations described in this permit.

#006 [25 Pa. Code § 127.441 and 35 P.S. § 4008]**Inspection and Entry.**

(a) Upon presentation of credentials and other documents as may be required by law, the permittee shall allow the Department or authorized representatives of the Department to perform the following:

(1) Enter at reasonable times upon the permittee's premises where a source is located or emissions related activity is conducted, or where records are kept under the conditions of this permit;

(2) Have access to and copy, at reasonable times, any records that are kept under the conditions of this permit;

(3) Inspect at reasonable times, any facilities, equipment including monitoring and air pollution control equipment, practices, or operations regulated or required under this permit;

(4) Sample or monitor, at reasonable times, any substances or parameters, for the purpose of assuring compliance with the permit or applicable requirements as authorized by the Clean Air Act, the Air Pollution Control Act, or the regulations promulgated under the Acts.

(b) Pursuant to 35 P.S. § 4008, no person shall hinder, obstruct, prevent or interfere with the Department or its personnel in the performance of any duty authorized under the Air Pollution Control Act or regulations adopted thereunder including denying the Department access to a source at this facility. Refusal of entry or access may constitute grounds for permit revocation and assessment of criminal and/or civil penalties.

(c) Nothing in this permit condition shall limit the ability of the EPA to inspect or enter the premises of the permittee in accordance with Section 114 or other applicable provisions of the Clean Air Act.

#007 [25 Pa. Code §§ 127.441 & 127.444]**Compliance Requirements.**

(a) The permittee shall comply with the conditions of this operating permit. Noncompliance with this permit constitutes a violation of the Clean Air Act and the Air Pollution Control Act and is grounds for one or more of the following:

**SECTION B. General State Only Requirements**

- (1) Enforcement action
- (2) Permit termination, revocation and reissuance or modification
- (3) Denial of a permit renewal application

(b) A person may not cause or permit the operation of a source which is subject to 25 Pa. Code Article III unless the source(s) and air cleaning devices identified in the application for the plan approval and operating permit and the plan approval issued for the source is operated and maintained in accordance with specifications in the applications and the conditions in the plan approval and operating permit issued by the Department. A person may not cause or permit the operation of an air contamination source subject to 25 Pa. Code Chapter 127 in a manner inconsistent with good operating practices.

(c) For purposes of Sub-condition (b) of this permit condition, the specifications in applications for plan approvals and operating permits are the physical configurations and engineering design details which the Department determines are essential for the permittee's compliance with the applicable requirements in this State-Only permit. Nothing in this sub-condition shall be construed to create an independent affirmative duty upon the permittee to obtain a predetermination from the Department for physical configuration or engineering design detail changes made by the permittee.

#008 [25 Pa. Code § 127.441]**Need to Halt or Reduce Activity Not a Defense.**

It shall not be a defense for the permittee in an enforcement action that it was necessary to halt or reduce the permitted activity in order to maintain compliance with the conditions of this permit.

#009 [25 Pa. Code §§ 127.442(a) & 127.461]**Duty to Provide Information.**

(a) The permittee shall submit reports to the Department containing information the Department may prescribe relative to the operation and maintenance of each source at the facility.

(b) The permittee shall furnish to the Department, in writing, information that the Department may request to determine whether cause exists for modifying, revoking and reissuing, or terminating this permit, or to determine compliance with the permit. Upon request, the permittee shall also furnish to the Department copies of records that the permittee is required to maintain in accordance with this permit.

#010 [25 Pa. Code § 127.461]**Revising an Operating Permit for Cause.**

This operating permit may be terminated, modified, suspended or revoked and reissued if one or more of the following applies:

- (1) The permittee constructs or operates the source subject to the operating permit so that it is in violation of the Air Pollution Control Act, the Clean Air Act, the regulations thereunder, a plan approval, a permit or in a manner that causes air pollution.
- (2) The permittee fails to properly or adequately maintain or repair an air pollution control device or equipment attached to or otherwise made a part of the source.
- (3) The permittee has failed to submit a report required by the operating permit or an applicable regulation.
- (4) The EPA determines that the permit is not in compliance with the Clean Air Act or the regulations thereunder.

#011 [25 Pa. Code §§ 127.450, 127.462, 127.465 & 127.703]**Operating Permit Modifications**

(a) The permittee is authorized to make administrative amendments, minor operating permit modifications and significant operating permit modifications, under this permit, as outlined below:

**SECTION B. General State Only Requirements**

(b) Administrative Amendments. The permittee shall submit the application for administrative operating permit amendments (as defined in 25 Pa. Code § 127.450(a)), according to procedures specified in § 127.450 unless precluded by the Clean Air Act or its regulations.

(c) Minor Operating Permit Modifications. The permittee shall submit the application for minor operating permit modifications (as defined 25 Pa. Code § 121.1) in accordance with 25 Pa. Code § 127.462.

(d) Significant Operating Permit Modifications. The permittee shall submit the application for significant operating permit modifications in accordance with 25 Pa. Code § 127.465.

(e) The applicable fees shall be made payable to "The Commonwealth of Pennsylvania Clean Air Fund" with the permit number clearly indicated and submitted to the respective regional office.

#012 [25 Pa. Code § 127.441]**Severability Clause.**

The provisions of this permit are severable, and if any provision of this permit is determined by a court of competent jurisdiction to be invalid or unenforceable, such a determination will not affect the remaining provisions of this permit.

#013 [25 Pa. Code § 127.449]**De Minimis Emission Increases.**

(a) This permit authorizes de minimis emission increases in accordance with 25 Pa. Code § 127.449 so long as the permittee provides the Department with seven (7) days prior written notice before commencing any de minimis emissions increase. The written notice shall:

(1) Identify and describe the pollutants that will be emitted as a result of the de minimis emissions increase.

(2) Provide emission rates expressed in tons per year and in terms necessary to establish compliance consistent with any applicable requirement.

(b) The Department may disapprove or condition de minimis emission increases at any time.

(c) Except as provided below in (d), the permittee is authorized to make de minimis emission increases (expressed in tons per year) up to the following amounts without the need for a plan approval or prior issuance of a permit modification:

(1) Four tons of carbon monoxide from a single source during the term of the permit and 20 tons of carbon monoxide at the facility during the term of the permit.

(2) One ton of NO_x from a single source during the term of the permit and 5 tons of NO_x at the facility during the term of the permit.

(3) One and six-tenths tons of the oxides of sulfur from a single source during the term of the permit and 8.0 tons of oxides of sulfur at the facility during the term of the permit.

(4) Six-tenths of a ton of PM₁₀ from a single source during the term of the permit and 3.0 tons of PM₁₀ at the facility during the term of the permit. This shall include emissions of a pollutant regulated under Section 112 of the Clean Air Act unless precluded by the Clean Air Act, the regulations thereunder or 25 Pa. Code Article III.

(5) One ton of VOCs from a single source during the term of the permit and 5.0 tons of VOCs at the facility during the term of the permit. This shall include emissions of a pollutant regulated under Section 112 of the Clean Air Act unless precluded by the Clean Air Act, the regulations thereunder or 25 Pa. Code Article III.

(6) Other sources and classes of sources determined to be of minor significance by the Department.

(d) In accordance with § 127.14, the permittee is authorized to install the following minor sources without the need for a plan approval or permit modification:

**SECTION B. General State Only Requirements**

- (1) Air conditioning or ventilation systems not designed to remove pollutants generated or released from other sources.
 - (2) Combustion units rated at 2,500,000 or less Btu per hour of heat input.
 - (3) Combustion units with a rated capacity of less than 10,000,000 Btu per hour heat input fueled by natural gas supplied by a public utility or by commercial fuel oils which are No. 2 or lighter, viscosity less than or equal to 5.82 c St, and which meet the sulfur content requirements of 25 Pa. Code §123.22 (relating to combustion units). For purposes of this permit, commercial fuel oil shall be virgin oil which has no reprocessed, recycled or waste material added.
 - (4) Space heaters which heat by direct heat transfer.
 - (5) Laboratory equipment used exclusively for chemical or physical analysis.
 - (6) Other sources and classes of sources determined to be of minor significance by the Department.
- (e) This permit does not authorize de minimis emission increases if the emissions increase would cause one or more of the following:
- (1) Increase the emissions of a pollutant regulated under Section 112 of the Clean Air Act except as authorized in Subparagraphs (c)(4) and (5) of this permit condition.
 - (2) Subject the facility to the prevention of significant deterioration requirements in 25 Pa. Code Chapter 127, Subchapter D and/or the new source review requirements in Subchapter E.
 - (3) Violate any applicable requirement of this permit, the Air Pollution Control Act, the Clean Air Act, or the regulations promulgated under either of the acts.
- (f) Emissions authorized under this permit condition shall be included in the monitoring, recordkeeping and reporting requirements of this permit.
- (g) Except for de minimis emission increases, installation of minor sources made pursuant to this permit condition and Plan Approval Exemptions under 25 Pa. Code § 127.14 (relating to exemptions), the permittee is prohibited from making changes or engaging in activities that are not specifically authorized under this permit without first applying for a plan approval. In accordance with § 127.14(b), a plan approval is not required for the construction, modification, reactivation, or installation of the sources creating the de minimis emissions increase.
- (h) The permittee may not meet de minimis emission threshold levels by offsetting emission increases or decreases at the same source.

#014 [25 Pa. Code § 127.3]**Operational Flexibility.**

The permittee is authorized to make changes within the facility in accordance with the regulatory provisions outlined in 25 Pa. Code § 127.3 (relating to operational flexibility) to implement the operational flexibility requirements provisions authorized under Section 6.1(i) of the Air Pollution Control Act and the operational flexibility terms and conditions of this permit. The provisions in 25 Pa. Code Chapter 127 which implement the operational flexibility requirements include the following:

- (1) Section 127.14 (relating to exemptions)
- (2) Section 127.447 (relating to alternative operating scenarios)
- (3) Section 127.448 (relating to emissions trading at facilities with Federally enforceable emissions caps)
- (4) Section 127.449 (relating to de minimis emission increases)
- (5) Section 127.450 (relating to administrative operating permit amendments)

**SECTION B. General State Only Requirements**

(6) Section 127.462 (relating to minor operating permit modifications)

(7) Subchapter H (relating to general plan approvals and general operating permits)

#015 [25 Pa. Code § 127.11]**Reactivation**

(a) The permittee may not reactivate a source that has been out of operation or production for at least one year unless the reactivation is conducted in accordance with a plan approval granted by the Department or in accordance with reactivation and maintenance plans developed and approved by the Department in accordance with 25 Pa. Code § 127.11a(a).

(b) A source which has been out of operation or production for more than five (5) years but less than 10 years may be reactivated and will not be considered a new source if the permittee satisfies the conditions specified in 25 Pa. Code § 127.11a(b).

#016 [25 Pa. Code § 127.36]**Health Risk-based Emission Standards and Operating Practice Requirements.**

(a) When needed to protect public health, welfare and the environment from emissions of hazardous air pollutants from new and existing sources, the permittee shall comply with the health risk-based emission standards or operating practice requirements imposed by the Department, except as precluded by §§ 6.6(d)(2) and (3) of the Air Pollution Control Act [35 P.S. § 4006.6(d)(2) and (3)].

(b) A person challenging a performance or emission standard established by the Department has the burden to demonstrate that performance or emission standard does not meet the requirements of Section 112 of the Clean Air Act.

#017 [25 Pa. Code § 121.9]**Circumvention.**

No person may permit the use of a device, stack height which exceeds good engineering practice stack height, dispersion technique or other technique which, without resulting in reduction of the total amount of air contaminants emitted, conceals or dilutes an emission of air contaminants which would otherwise be in violation of 25 Pa. Code Article III, except that with prior approval of the Department, the device or technique may be used for control of malodors.

#018 [25 Pa. Code §§ 127.402(d) & 127.442]**Reporting Requirements.**

(a) The permittee shall comply with the applicable reporting requirements of the Clean Air Act, the regulations thereunder, the Air Pollution Control Act and 25 Pa. Code Article III including Chapters 127, 135 and 139.

(b) The permittee shall submit reports to the Department containing information the Department may prescribe relative to the operation and maintenance of any air contamination source.

(c) Reports, test data, monitoring data, notifications and requests for renewal of the permit shall be submitted to the:

Regional Air Program Manager
PA Department of Environmental Protection
(At the address given in the permit transmittal letter, or otherwise notified)

(d) Any records or information including applications, forms, or reports submitted pursuant to this permit condition shall contain a certification by a responsible official as to truth, accuracy and completeness. The certifications submitted under this permit shall require a responsible official of the facility to certify that based on information and belief formed after reasonable inquiry, the statements and information in the documents are true, accurate and complete.

(e) Any records, reports or information submitted to the Department shall be available to the public except for such

**SECTION B. General State Only Requirements**

records, reports or information which meet the confidentiality requirements of § 4013.2 of the Air Pollution Control Act and §§ 112(d) and 114(c) of the Clean Air Act. The permittee may not request a claim of confidentiality for any emissions data generated for the facility.

#019 [25 Pa. Code §§ 127.441(c) & 135.5]**Sampling, Testing and Monitoring Procedures.**

(a) The permittee shall comply with the monitoring, recordkeeping or reporting requirements of 25 Pa. Code Chapter 139 and the other applicable requirements of 25 Pa. Code Article III and additional requirements related to monitoring, reporting and recordkeeping required by the Clean Air Act and the regulations thereunder including the Compliance Assurance Monitoring requirements of 40 CFR Part 64, where applicable.

(b) Unless alternative methodology is required by the Clean Air Act and regulations adopted thereunder, sampling, testing and monitoring required by or used by the permittee to demonstrate compliance with any applicable regulation or permit condition shall be conducted in accordance with the requirements of 25 Pa. Code Chapter 139.

#020 [25 Pa. Code §§ 127.441(c) and 135.5]**Recordkeeping.**

(a) The permittee shall maintain and make available, upon request by the Department, the following records of monitored information:

- (1) The date, place (as defined in the permit) and time of sampling or measurements.
- (2) The dates the analyses were performed.
- (3) The company or entity that performed the analyses.
- (4) The analytical techniques or methods used.
- (5) The results of the analyses.
- (6) The operating conditions as existing at the time of sampling or measurement.

(b) The permittee shall retain records of any required monitoring data and supporting information for at least five (5) years from the date of the monitoring, sample, measurement, report or application. Supporting information includes the calibration data and maintenance records and original strip-chart recordings for continuous monitoring instrumentation, and copies of reports required by the permit.

(c) The permittee shall maintain and make available to the Department upon request, records including computerized records that may be necessary to comply with the reporting, recordkeeping and emission statement requirements in 25 Pa. Code Chapter 135 (relating to reporting of sources). In accordance with 25 Pa. Code Chapter 135, § 135.5, such records may include records of production, fuel usage, maintenance of production or pollution control equipment or other information determined by the Department to be necessary for identification and quantification of potential and actual air contaminant emissions.

#021 [25 Pa. Code § 127.441(a)]**Property Rights.**

This permit does not convey any property rights of any sort, or any exclusive privileges.

#022 [25 Pa. Code § 127.447]**Alternative Operating Scenarios.**

The permittee is authorized to make changes at the facility to implement alternative operating scenarios identified in this permit in accordance with 25 Pa. Code § 127.447.

**SECTION B. General State Only Requirements****#023 [25 Pa. Code §135.3]****Reporting**

(a) If the facility is a Synthetic Minor Facility, the permittee shall submit by March 1 of each year an annual emissions report for the preceding calendar year. The report shall include information for all active previously reported sources, new sources which were first operated during the preceding calendar year, and sources modified during the same period which were not previously reported. All air emissions from the facility should be estimated and reported.

(b) A source owner or operator of a Synthetic Minor Facility may request an extension of time from the Department for the filing of an annual emissions report, and the Department may grant the extension for reasonable cause.

#024 [25 Pa. Code §135.4]**Report Format**

If applicable, the emissions reports shall contain sufficient information to enable the Department to complete its emission inventory. Emissions reports shall be made by the source owner or operator in a format specified by the Department.

**SECTION C. Site Level Requirements****I. RESTRICTIONS.****Emission Restriction(s).****# 001 [25 Pa. Code §123.1]****Prohibition of certain fugitive emissions**

(a) No person may permit the emission into the outdoor atmosphere of fugitive air contaminants from a source other than the following:

- (1) Construction or demolition of buildings or structures
- (2) Grading, paving and maintenance of roads and streets
- (3) Use of roads and streets. Emissions from material in or on trucks, railroad cars and other vehicular equipment are not considered as emissions from use of roads and streets.
- (4) Clearing of land
- (5) Stockpiling of materials.
- (6) Open burning operations.
- (7) Sources and classes of sources other than those identified above, for which the permittee has obtained a determination from the Department that fugitive emissions from the source, after appropriate control, meet the following requirements:
 - (i) The emissions are of minor significance with respect to causing air pollution.
 - (ii) The emissions are not preventing or interfering with the attainment or maintenance of any ambient air quality standard.

002 [25 Pa. Code §123.2]**Fugitive particulate matter**

No person may permit fugitive particulate matter to be emitted into the outdoor atmosphere from a source specified in Condition #001(a)(1) - (a)(7) above if the emissions are visible at the point the emissions pass outside the person's property.

003 [25 Pa. Code §123.41]**Limitations**

No person may permit the emission into the outdoor atmosphere of visible air contaminants in such a manner that the opacity of the emission is either of the following:

- (1) Equal to or greater than 20% for a period or periods aggregating more than three minutes in any 1 hour.
- (2) Equal to or greater than 60% at any time.

004 [25 Pa. Code §123.42]**Exceptions**

The emission limitations of 25 Pa. Code Section 123.41 shall not apply when:

- (1) The presence of uncombined water is the only reason for failure of the emission to meet the limitations;
- (2) The emission results from the operation of equipment used solely to train and test persons in observing the opacity of visible emissions;
- (3) The emission results from sources specified in 25 Pa. Code Section 123.1(a)(1)-(9).

005 [25 Pa. Code §127.441]**Operating permit terms and conditions.**

[Additional authority for this operating permit condition is derived from the permittee requesting this restriction to become a synthetic minor facility]

**SECTION C. Site Level Requirements**

The nitrogen oxide (NO_x) emissions from all sources at this facility shall not equal or exceed 100 tons in any 12 consecutive month period..

The carbon monoxide (CO) emissions from all sources at this facility shall not equal or exceed 100 tons in any 12 consecutive month period.

Throughput Restriction(s).**# 006 [25 Pa. Code §127.441]****Operating permit terms and conditions.**

[Additional authority for this operating permit condition is derived from the permittee requesting this restriction to become a synthetic minor facility]

The total amount of natural gas burned in all sources at this facility shall not exceed 1,941 MMSCF in any 12 consecutive month period.

II. TESTING REQUIREMENTS.**# 007 [25 Pa. Code §127.441]****Operating permit terms and conditions.**

(a) Pursuant to 25 Pa. Code § 139.3, at least 90 calendar days prior to commencing a EPA reference method testing program, a test protocol shall be submitted to the Department for review and approval. One electronic copy shall be sent to the Northcentral Regional Office Air Quality Program Manager and one electronic copy shall be sent to the PSIMS Administrator in Central Office. The test protocol shall meet all applicable requirements specified in the most current version of the Department's Source Testing Manual.

(b) Pursuant to 25 Pa. Code § 139.3, at least 15 calendar days prior to commencing an emission testing program, notification as to the date and time of testing shall be given to the Northcentral Regional Office. Notification shall also be sent to the Division of Source Testing and Monitoring. Notification shall not be made without prior receipt of a protocol acceptance letter from the Department.

(c) If applicable, pursuant to 40 CFR § 60.8(a), 40 CFR § 61.13(f) and 40 CFR § 63.7(g), complete test reports shall be submitted to the Department no later than 60 calendar days after completion of the on-site testing portion of an EPA reference method test program.

(d) Pursuant to 25 Pa. Code § 139.53(b) a complete test report shall include a summary of the emission results on the first page of the report indicating if each pollutant measured is within permitted limits and a statement of compliance or noncompliance with all applicable permit conditions. The summary results will include, at a minimum, the following information:

1. A statement that the owner or operator has reviewed the report from the emissions testing body and agrees with the findings.
2. Permit number(s) and condition(s) which are the basis for the evaluation.
3. Summary of results with respect to each applicable permit condition.
4. Statement of compliance or non-compliance with each applicable permit condition.

(e) Pursuant to 25 Pa. Code § 139.3, all submittals shall meet all applicable requirements specified in the most current version of the Department's Source Testing Manual.

(f) All testing shall be performed in accordance with the provisions of Chapter 139 of the Rules and Regulations of the Department of Environmental Protection.

(g) Pursuant to 25 Pa. Code § § 139.53(a)(1) and 139.53(a)(3), electronic copies of all submittals, besides notifications, shall be sent to the Northcentral Regional Office Air Quality Program Manager, with deadlines verified. In addition, an electronic copy shall be sent to the PSIMS Administrator in Central Office. Email addresses are provided on the PA DEP website.

**SECTION C. Site Level Requirements**

(h) The permittee shall insure all federal reporting requirements contained in the applicable subpart of 40 CFR are followed, including timelines more stringent than those contained herein. In the event of an inconsistency or any conflicting requirements between state and the federal, the most stringent provision, term, condition, method or rule shall be used by default.

008 [25 Pa. Code §127.441]**Operating permit terms and conditions.**

The permittee shall perform tests (in accordance with the provisions of 25 Pa. Code Chapter 139) or provide a fuel analysis report of the percent sulfur by weight for each delivery of the #2 oil delivered to this facility,

OR

The permittee shall provide a fuel analysis report obtained from the supplier once a year stating that the sulfur percentage for each shipment of fuel delivered to the facility during the year shall not exceed the maximum sulfur content as specified by 25 Pa Code Section 123.22.

009 [25 Pa. Code §139.1]**Sampling facilities.**

Upon the request of the Department, the permittee shall provide adequate sampling ports, safe sampling platforms and adequate utilities for the performance by the Department of tests on such source. The Department will set forth, in the request, the time period in which the facilities shall be provided as well as the specifications for such facilities.

010 [25 Pa. Code §139.11]**General requirements.**

(a) As specified in 25 Pa. Code Section 139.11(1), performance tests shall be conducted while the source is operating at maximum routine operating conditions or under such other conditions, within the capacity of the equipment, as may be requested by the Department.

(b) As specified in 25 Pa. Code Section 139.11(2), the Department will consider test results for approval where sufficient information is provided to verify the source conditions existing at the time of the test and where adequate data is available to show the manner in which the test was conducted. Information submitted to the Department shall include, as a minimum, all of the following:

- (1) A thorough source description, including a description of any air cleaning devices and the flue.
- (2) Process conditions, for example, the charging rate of raw material or rate of production of final product, boiler pressure, oven temperature and other conditions which may effect emissions from the process.
- (3) The location of sampling ports.
- (4) Effluent characteristics, including velocity, temperature, moisture content, gas density (percentage of CO, CO₂, O₂ and N₂), static and barometric pressures.
- (5) Sample collection techniques employed, including procedures used, equipment descriptions and data to verify that isokinetic sampling for particulate matter collection occurred and that acceptable test conditions were met.
- (6) Laboratory procedures and results.
- (7) Calculated results.

III. MONITORING REQUIREMENTS.**# 011 [25 Pa. Code §123.43]****Measuring techniques**

Visible emissions may be measured using either of the following:

**SECTION C. Site Level Requirements**

- (1) A device approved by the Department and maintained to provide accurate opacity measurements.
- (2) Observers, trained and qualified, to measure plume opacity with the naked eye or with the aid of any devices approved by the Department.

012 [25 Pa. Code §127.441]**Operating permit terms and conditions.**

(a) The permittee shall conduct a weekly inspection around the plant periphery during daylight hours when the plant is in production to detect visible emissions, fugitive visible emissions and malodorous air emissions. Weekly inspections are necessary to determine:

- (1) the presence of visible emissions,
- (2) the presence of visible fugitive emissions,
- (3) the presence of malodors beyond the plant property boundaries.

(b) All detected visible emissions, visible fugitive emissions, and malodors shall be reported to the manager of the facility.

IV. RECORDKEEPING REQUIREMENTS.**# 013 [25 Pa. Code §127.441]****Operating permit terms and conditions.**

(a) The permittee shall maintain a logbook for recording instances of visible emissions, fugitive visible emissions and malodorous air emissions, the name of the company representative monitoring these instances, the date and time of each occurrence, and the wind direction during each instance. The permittee shall also record the corrective actions taken or preventative measures taken at each instance.

(b) These records shall be retained for a minimum of 5 years and shall be made available to the Department upon request.

014 [25 Pa. Code §127.441]**Operating permit terms and conditions.**

(a) The permittee shall keep records of tests or fuel certification reports of the percent sulfur by weight for each delivery of the #2 oil delivered to the facility,

OR

The permittee shall keep records of fuel certification reports obtained yearly from the #2 fuel oil supplier stating that the sulfur percentage for each shipment of fuel delivered to the facility during the year shall not exceed the limits specified in 25 Pa. Code Section 123.22.

(b) These records shall be made available to the Department upon request and shall remain on file for five years.

015 [25 Pa. Code §127.441]**Operating permit terms and conditions.**

The permittee shall keep records of the amount of natural gas burned at the facility each month and the corresponding 12 consecutive month period totals to verify compliance with the throughput limitation for the facility. These records shall be retained for a minimum of five years and be presented to the Department upon request.

016 [25 Pa. Code §135.5]**Recordkeeping**

Source owners or operators shall maintain and make available upon request by the Department records including computerized records that may be necessary to comply with Sections 135.3 and 135.21 (relating to reporting; and emission statements). These may include records of production, fuel usage, maintenance of production or pollution control equipment or other information determined by the Department to be necessary for identification and quantification of potential and actual air contaminant emissions.

**SECTION C. Site Level Requirements****V. REPORTING REQUIREMENTS.****# 017 [25 Pa. Code §127.441]****Operating permit terms and conditions.**

The permittee shall keep submit semi-annual reports to the Department which contain the amount of natural gas burned at the facility each month for the previous 12 consecutive month period and the corresponding 12 consecutive month period totals to verify compliance with the throughput limitation for the facility. These reports shall be submitted no later than March 1 and September 1 each year.

018 [25 Pa. Code §127.441]**Operating permit terms and conditions.**

Upon request by the Department, the permittee shall submit all requested reports in accordance with the Department's suggested format.

019 [25 Pa. Code §127.442]**Reporting requirements.**

(a) The permittee shall report malfunctions, emergencies or incidents of excess emissions to the Department. A malfunction is any sudden, infrequent, and not reasonably preventable failure of air pollution control equipment, process equipment, or a process to operate in a normal or usual manner. An emergency is any situation arising from sudden and reasonably unforeseeable events beyond the control of the owner or operator of a facility which requires immediate corrective action to restore normal operation and which causes the emission source to exceed emissions, due to unavoidable increases in emissions attributable to the situation. An emergency shall not include situations caused by improperly designed equipment, lack of preventive maintenance, careless or improper operation, or operator error.

(b) When the malfunction, emergency or incident of excess emissions poses an imminent danger to the public health, safety, welfare, or environment, it shall be reported to the Department and the County Emergency Management Agency by telephone within one (1) hour after the discovery of the malfunction, emergency or incident of excess emissions. The owner or operator shall submit a written or emailed report of instances of such malfunctions, emergencies or incidents of excess emissions to the Department within three (3) business days of the telephone report.

(c) The report shall describe the following:

1. name, permit or authorization number, and location of the facility,
2. nature and cause of the malfunction, emergency or incident,
3. date and time when the malfunction, emergency or incident was first observed,
4. expected duration of excess emissions,
5. estimated rate of emissions,
6. corrective actions or preventative measures taken.

(d) Any malfunction, emergency or incident of excess emissions that is not subject to the notice requirements of paragraph (b) of this condition shall be reported to the Department by telephone within 24 hours (or by 4:00 PM of the next business day, whichever is later) of discovery and in writing or by e-mail within five (5) business days of discovery. The report shall contain the same information required by paragraph (c), and any permit specific malfunction reporting requirements.

(e) During an emergency an owner or operator may continue to operate the source at their discretion provided they submit justification for continued operation of a source during the emergency and follow all the notification and reporting requirements in accordance with paragraphs (b)-(d), as applicable, including any permit specific malfunction reporting requirements.

(f) Reports regarding malfunctions, emergencies or incidents of excess emissions shall be submitted to the appropriate DEP Regional Office Air Program Manager.

(g) Any emissions resulted from malfunction or emergency are to be reported in the annual emissions inventory report, if the annual emissions inventory report is required by permit or authorization.

020 [25 Pa. Code §135.21]**Emission statements**

(a) The permittee shall provide the Department with a statement of each stationary source in a form as prescribed by the

**SECTION C. Site Level Requirements**

Department, showing the actual emissions of oxides of nitrogen and volatile organic compounds (VOCs) from the permitted facility for each reporting period, a description of the method used to calculate the emissions and the time period over which the calculation is based.

(b) The annual emission statements are due by March 1 for the preceding calendar year and shall contain a certification by a company officer or the plant manager that the information contained in the statement is accurate. The Emission Statement shall provide data consistent with requirements and guidance developed by the EPA.

(c) The Department may require more frequent submittals if the Department determines that one or more of the following applies:

(1) A more frequent submission is required by the EPA.

(2) Analysis of the data on a more frequent basis is necessary to implement the requirements of the Air Pollution Control Act.

VI. WORK PRACTICE REQUIREMENTS.**# 021 [25 Pa. Code §123.1]****Prohibition of certain fugitive emissions**

For any source specified in 25 Pa. Code Section 123.1 subsection(s) (a)(1)-(7) or (a)(9), the permittee shall take all reasonable actions to prevent particulate matter from becoming airborne. These actions shall include, but not be limited to, the following:

(1) Use, where possible, of water or chemicals for control of dust in the demolition of buildings or structures, construction operations, the grading of roads or the clearing of land.

(2) Application of asphalt, oil, or suitable chemicals on dirt roads, material stockpiles and other surfaces which may give rise to airborne dusts.

(3) Paving and maintenance of roadways.

(4) Prompt removal of earth or other material from paved streets onto which earth or other material has been transported by trucking or earth moving equipment, erosion by water, or other means.

VII. ADDITIONAL REQUIREMENTS.**# 022 [25 Pa. Code §121.7]****Prohibition of air pollution.**

No person may permit air pollution as that term is defined in the act (The Air Pollution Control Act (35 P.S. §§ 4001-4015)).

023 [25 Pa. Code §123.31]**Limitations**

No person may permit the emission into the outdoor atmosphere of any malodorous air contaminants from any source in a manner that the malodors are detectable outside the property of the person on whose land the source is being operated.

024 [25 Pa. Code §129.14]**Open burning operations**

No person may permit the open burning of material at this facility unless in accordance with 25 Pa. Code Section 129.14.

VIII. COMPLIANCE CERTIFICATION.

No additional compliance certifications exist except as provided in other sections of this permit including Section B (relating to State Only General Requirements).

IX. COMPLIANCE SCHEDULE.

No compliance milestones exist.

**SECTION D. Source Level Requirements**

Source ID: 031

Source Name: 4 BOILERS

Source Capacity/Throughput:

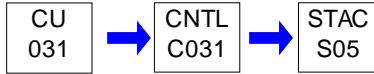
**I. RESTRICTIONS.**

No additional requirements exist except as provided in other sections of this permit including Section B (State Only General Requirements).

II. TESTING REQUIREMENTS.

No additional testing requirements exist except as provided in other sections of this permit including Section B (State Only General Requirements).

III. MONITORING REQUIREMENTS.

No additional monitoring requirements exist except as provided in other sections of this permit including Section B (State Only General Requirements).

IV. RECORDKEEPING REQUIREMENTS.

No additional record keeping requirements exist except as provided in other sections of this permit including Section B (State Only General Requirements).

V. REPORTING REQUIREMENTS.

No additional reporting requirements exist except as provided in other sections of this permit including Section B (State Only General Requirements).

VI. WORK PRACTICE REQUIREMENTS.

No additional work practice requirements exist except as provided in other sections of this permit including Section B (State Only General Requirements).

VII. ADDITIONAL REQUIREMENTS.**# 001 [25 Pa. Code §127.441]****Operating permit terms and conditions.**

(a) Source ID 031 consists of four (4) 37.0 MMBTU/hr E. Keeler type CP underfeed stoker bituminous coal-fired boilers that have been permanently shut down at the facility. These boilers shall not be reactivated under any circumstance.

(b) The permittee has been granted emission reduction credits (ERCs) of 94.15 tons per year NO_x, 12.88 tons per year VOCs, 36.79 tons per year PM-10 and 228.29 tons per year SO_x for the shutdown of all boilers of Source ID 031.

**SECTION D. Source Level Requirements**

Source ID: 036

Source Name: BOILER 6

Source Capacity/Throughput: 108.000 MMBTU/HR

104.200 MCF/HR Natural Gas

**I. RESTRICTIONS.****Emission Restriction(s).****# 001 [25 Pa. Code §123.11]****Combustion units**

A person may not permit the emission into the outdoor atmosphere of particulate matter from Source ID 036 in excess of the following:

- 1) The rate of 0.4 pound per million Btu of heat input, when the heat input to the combustion unit in millions of Btus per hour is greater than 2.5 but less than 50, in accordance with 25 Pa. Code Section 123.11(a)(1).
- 2) The rate determined by the following formula, in accordance with 25 Pa. Code Section 123.11(a)(2):

$$A = 3.6 * E^{(-0.56)}$$

where

A = Allowable emissions in pounds per million Btus of heat input

E = Heat input to the combustion unit in millions of Btus per hour

002 [25 Pa. Code §123.22]**Combustion units**

[Compliance with the requirement specified in this streamlined permit condition assures compliance with the provision in 40 CFR 52.2020(c)]

No person may permit the emission into the outdoor atmosphere of Sulfur Oxides (SO_x), expressed as SO₂, from Source ID 036 in excess of the rate of 4 pounds per million Btu of heat input over any 1-hour period in accordance with 25 Pa. Code Section 123.22(a)(1).

003 [25 Pa. Code §127.441]**Operating permit terms and conditions.**

[Additional authority for this permit condition is derived from 25 Pa. Code Sections 129.91 through 129.95.]

- a) The permittee shall not emit nitrogen oxides at a rate in excess of 0.1 pounds per million BTU of heat input.
- b) Compliance with this emission limitation shall be determined based on the arithmetic average of at least three individual test runs required by this operating permit.

Fuel Restriction(s).**# 004 [25 Pa. Code §127.441]****Operating permit terms and conditions.**

[Additional authority for this operating permit condition is derived from the permittee requesting this restriction to become a synthetic minor facility]

**SECTION D. Source Level Requirements**

Source ID 036 shall only be fired on natural gas.

II. TESTING REQUIREMENTS.

005 [25 Pa. Code §127.441]

Operating permit terms and conditions.

[Additional authority for this permit condition is derived from 25 Pa. Code Sections 129.91]

During the period January 1, 2026 to December 31, 2026, Source ID 036 shall undergo stack testing to determine compliance with the nitrogen oxides emission limitations. The permittee shall also conduct CO emissions testing to determine the short term emission rate of CO. This testing shall be conducted in accordance with the provisions of 25 Pa. Code Chapter 139 and the Testing Requirements located in Section C of this operating permit, and is to be performed at or near full load conditions.

III. MONITORING REQUIREMENTS.

No additional monitoring requirements exist except as provided in other sections of this permit including Section B (State Only General Requirements).

IV. RECORDKEEPING REQUIREMENTS.

006 [25 Pa. Code §127.441]

Operating permit terms and conditions.

[Additional authority for this permit condition is derived from 25 Pa. Code Sections 129.91 through 129.95]

(a) The permittee shall maintain records of the following operating parameters for Source ID 036:

- (1) The total number of hours operated per month and the number of hours operated per month.
- (2) The amount of natural gas burned in Source ID 036 each month.
- (2) Calculations used to verify compliance with the SO₂, particulate matter, and NO_x emissions limitations for Source ID 036.

(b) These records shall be made available to the Department upon request and shall remain on file for five years.

V. REPORTING REQUIREMENTS.

007 [25 Pa. Code §127.441]

Operating permit terms and conditions.

[Additional authority for this permit condition is derived from 25 Pa. Code Section 129.95]

(a) The permittee shall submit to the Department on an annual basis records of the following operating parameters for Source ID 036:

- (1) The total number of hours operated per month.
- (2) The total amount of natural gas burned each month.

(b) All annual reports shall be submitted to the Department by March 1 for the preceding period January to December.

**SECTION D. Source Level Requirements****# 008 [25 Pa. Code §127.441]****Operating permit terms and conditions.**

Compliance with Condition #007 of this Source ID shall be achieved by the permittee submitting their annual AIMS by March 1st in accordance with Condition #023 of Section B of this Synthetic Minor Operating Permit. No additional report is required to be submitted.

VI. WORK PRACTICE REQUIREMENTS.

No additional work practice requirements exist except as provided in other sections of this permit including Section B (State Only General Requirements).

VII. ADDITIONAL REQUIREMENTS.**# 009 [25 Pa. Code §127.441]****Operating permit terms and conditions.**

Source ID 036 is an E. Keeler type DS10-20, 108 million BTU per hour natural gas fired boiler located in the Main Plant Boiler House.

010 [40 CFR Part 63 NESHAPS for Source Categories §40 CFR 63.11195]**SUBPART JJJJJJ - National Emission Standards for Hazardous Air Pollutants for Industrial, Commercial, and Institutional Boilers Area Sources****Are any boilers not subject to this subpart?**

Source ID 036 is not subject to 40 CFR Part 63 Subpart JJJJJJ, National Emission Standards for Hazardous Air Pollutants for Industrial, Commercial, and Institutional Boilers Area Sources, because it is a gas fired unit as defined by 40 CFR part 63 Section 63.11237.

**SECTION D. Source Level Requirements**

Source ID: 039

Source Name: BOILER 7

Source Capacity/Throughput: 92.000 MMBTU/HR

90.196 MCF/HR

Natural Gas

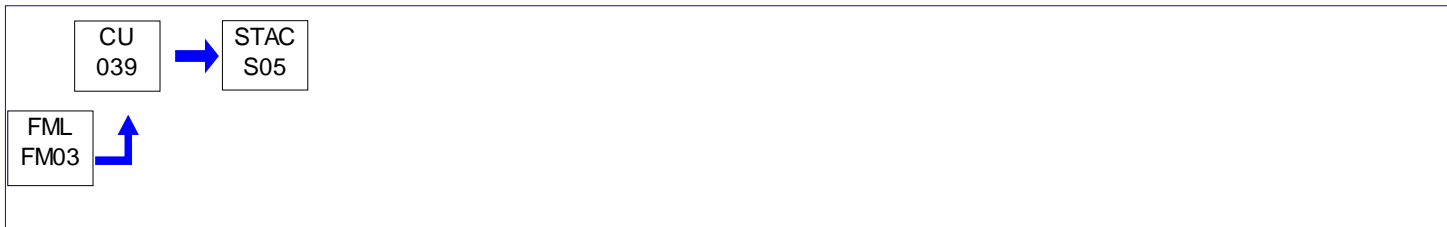
**I. RESTRICTIONS.****Emission Restriction(s).****# 001 [25 Pa. Code §123.11]****Combustion units**

A person may not permit the emission into the outdoor atmosphere of particulate matter from Source ID 039 in excess of the following:

- 1) The rate of 0.4 pound per million Btu of heat input, when the heat input to the combustion unit in millions of Btus per hour is greater than 2.5 but less than 50, in accordance with 25 Pa. Code Section 123.11(a)(1).
- 2) The rate determined by the following formula, in accordance with 25 Pa. Code Section 123.11(a)(2):

$$A = 3.6 * E^{(-0.56)}$$

where

A = Allowable emissions in pounds per million Btus of heat input

E = Heat input to the combustion unit in millions of Btus per hour

002 [25 Pa. Code §123.22]**Combustion units**

[Compliance with the requirement specified in this streamlined permit condition assures compliance with the provision in 40 CFR 52.2020(c)]

No person may permit the emission into the outdoor atmosphere of Sulfur Oxides (SO_x), expressed as SO₂, from Source ID 039 in excess of the rate of 4 pounds per million Btu of heat input over any 1-hour period in accordance with 25 Pa. Code Section 123.22(a)(1).

003 [25 Pa. Code §127.441]**Operating permit terms and conditions.**

[Additional authority for this permit condition is derived from 25 Pa. Code Section 129.91 through 129.95.]

- (a) The permittee shall not emit nitrogen oxides at a rate in excess of 0.1 pounds per million BTU of heat input.
- (b) Compliance with this limitation shall be determined based on the arithmetic average of at least three individual test runs required by this operating permit.

Fuel Restriction(s).**# 004 [25 Pa. Code §127.441]****Operating permit terms and conditions.**

[Additional authority for this operating permit condition is derived from the permittee requesting this restriction to become a synthetic minor facility]

**SECTION D. Source Level Requirements**

Source ID 039 shall only be fired on natural gas.

Throughput Restriction(s).

005 [25 Pa. Code §127.441]

Operating permit terms and conditions.

[Additional authority for this permit condition is also derived from the permittee requesting this elective restriction]

The firing rate for Source ID 039 shall not exceed 90,196 cubic feet per hour when firing natural gas.

II. TESTING REQUIREMENTS.

006 [25 Pa. Code §127.441]

Operating permit terms and conditions.

[Additional authority for this permit condition is derived from 25 Pa. Code Sections 129.91]

During the period January 1, 2026 to December 31, 2026, Source ID 039 shall undergo stack testing to determine compliance with the nitrogen oxides emission limitations. The permittee shall also conduct CO emissions testing to determine the short term emission rate of CO. This testing shall be conducted in accordance with the provisions of 25 Pa. Code Chapter 139 and the Testing Requirements located in Section C of this operating permit, and is to be performed at or near full load conditions.

III. MONITORING REQUIREMENTS.

No additional monitoring requirements exist except as provided in other sections of this permit including Section B (State Only General Requirements).

IV. RECORDKEEPING REQUIREMENTS.

007 [25 Pa. Code §127.441]

Operating permit terms and conditions.

[Additional authority for this permit condition is derived from 25 Pa. Code Sections 129.91 through 129.95]

(a) The permittee shall maintain records of the following operating parameters for Source ID 039:

- (1) The total number of hours Source ID 039 is operated each day.
- (2) The amount of natural gas burned each day in Source ID 039.
- (3) Calculations used to verify compliance with the SO_x, particulate matter, and NO_x emissions limitations for Source ID 039.
- (4) Calculations verifying compliance with the firing rate restriction for Source ID 039 on a daily basis.

(b) These records shall be made available to the Department upon request and shall remain on file for five years.

V. REPORTING REQUIREMENTS.

008 [25 Pa. Code §127.441]

Operating permit terms and conditions.

[Additional authority for this permit condition is derived from 25 Pa. Code Section 129.91 - 129.95]

(a) The permittee shall submit to the Department on an annual basis records of the following operating parameters for Source ID 039:

**SECTION D. Source Level Requirements**

(1) The total number of hours Source ID 039 is operated each month.

(2) The amount of natural gas burned in Source ID 039 each month.

(b) All annual reports shall be submitted to the Department by March 1 for the preceding period January to December.

009 [25 Pa. Code §127.441]

Operating permit terms and conditions.

Compliance with Condition #008 of this Source ID shall be achieved by the permittee submitting their annual AIMS by March 1st in accordance with Condition #023 of Section B of this Synthetic Minor Operating Permit. No additional report is required to be submitted.

VI. WORK PRACTICE REQUIREMENTS.

No additional work practice requirements exist except as provided in other sections of this permit including Section B (State Only General Requirements).

VII. ADDITIONAL REQUIREMENTS.

010 [25 Pa. Code §127.441]

Operating permit terms and conditions.

Source ID 039 is an E. Keeler type DS10-21, 116 million Btu per hour natural gas fired boiler located in the Main Plant Boiler House.

011 [25 Pa. Code §127.441]

Operating permit terms and conditions.

[Additional authority for this permit condition is also derived from the permittee requesting this elective restriction]

Source ID 039 shall not be operated at a capacity of greater than 92 MMBTU/hr. Compliance with this permit requirement will be shown by meeting the firing rate restrictions of Condition #005.

012 [40 CFR Part 63 NESHAPS for Source Categories §40 CFR 63.11195]

SUBPART JJJJJJ - National Emission Standards for Hazardous Air Pollutants for Industrial, Commercial, and Institutional Boilers Area Sources

Are any boilers not subject to this subpart?

Source ID 039 is not subject to 40 CFR Part 63 Subpart JJJJJJ, National Emission Standards for Hazardous Air Pollutants for Industrial, Commercial, and Institutional Boilers Area Sources, because it is a gas fired unit as defined by 40 CFR part 63 Section 63.11237.

**SECTION D. Source Level Requirements**

Source ID: 040

Source Name: BOILER 8

Source Capacity/Throughput: 96.800 MMBTU/HR

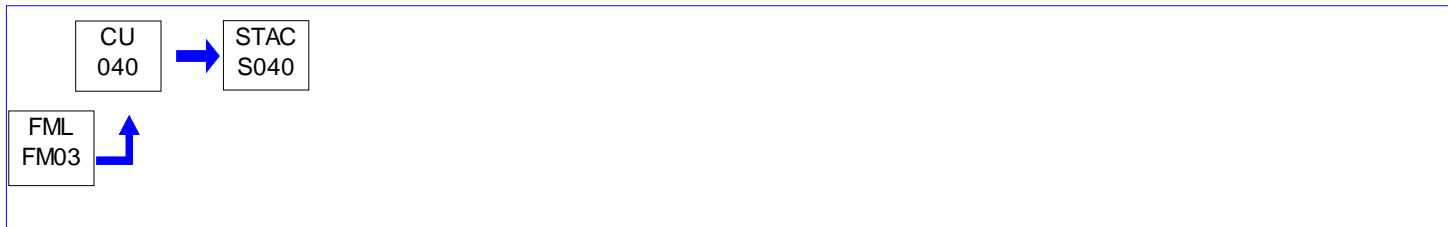
**I. RESTRICTIONS.****Emission Restriction(s).****# 001 [25 Pa. Code §123.11]****Combustion units**

A person may not permit the emission into the outdoor atmosphere of particulate matter from Source ID 040 in excess of the following:

- 1) The rate of 0.4 pound per million Btu of heat input, when the heat input to the combustion unit in millions of Btus per hour is greater than 2.5 but less than 50, in accordance with 25 Pa. Code Section 123.11(a)(1).
- 2) The rate determined by the following formula, in accordance with 25 Pa. Code Section 123.11(a)(2):

$$A = 3.6 \cdot E^{(-0.56)}$$

Where

A = Allowable emissions in pounds per million Btus of heat input

E = Heat input to the combustion unit in millions of Btus per hour

002 [25 Pa. Code §123.22]**Combustion units**

[Compliance with the requirement specified in this streamlined permit condition assures compliance with the provision in 40 CFR 52.2020(c)]

No person may permit the emission into the outdoor atmosphere of Sulfur Oxides (SO_x), expressed as SO₂, from Source ID 040 in excess of the rate of 4 pounds per million Btu of heat input over any 1-hour period in accordance with 25 Pa. Code Section 123.22(a)(1).

003 [25 Pa. Code §127.441]**Operating permit terms and conditions.**

[Additional authority for this permit condition is derived from 25 Pa. Code Section 127.1 and 127.12]

The emission of carbon monoxide from Source ID 040 shall not at any time exceed 0.1 lb/MMBtu and the emission of volatile organic compounds shall not at any time exceed 0.005 lb/MMBtu. Additionally, total carbon monoxide and volatile organic compound emissions from Source ID 040 shall not exceed 42.4 tons and 2.12 tons, respectively, in any 12 consecutive month period.

004 [25 Pa. Code §127.441]**Operating permit terms and conditions.**

[Additional authority for this permit condition is derived from 25 Pa. Code Section 127.1 and 127.12]

The emission of nitrogen oxides (NO_x, expressed as NO₂) from Source ID 040 shall not at any time exceed 0.04 pounds per million BTU of boiler heat input (lb/MMBtu) when firing natural gas. Additionally, total NO_x emissions from Source ID 040 shall not exceed 24.4 tons in any 12 consecutive month period.

**SECTION D. Source Level Requirements****Fuel Restriction(s).****# 005 [25 Pa. Code §127.441]****Operating permit terms and conditions.**

[Additional authority for this operating permit condition is derived from the permittee requesting this restriction to become a synthetic minor facility]

Source ID 040 shall only be fired on natural gas.

II. TESTING REQUIREMENTS.**# 006 [25 Pa. Code §127.441]****Operating permit terms and conditions.**

Sometime during the period January 1, 2026 to December 31, 2026, the permittee shall perform nitrogen oxides and carbon monoxide stack testing on the exhaust of Source ID 040. This testing shall be conducted in accordance with the provisions of 25 Pa. Code Chapter 139 and the Testing Requirements located in Section C of this operating permit, and is to be performed at or near full load conditions.

III. MONITORING REQUIREMENTS.**# 007 [25 Pa. Code §127.441]****Operating permit terms and conditions.**

[Additional authority for this permit condition is derived from 25 Pa. Code Section 127.1 and 127.12]

The natural gas feed line serving Source ID 040 shall be equipped with a flow meter to continuously monitor the fuel usage.

IV. RECORDKEEPING REQUIREMENTS.**# 008 [25 Pa. Code §127.441]****Operating permit terms and conditions.**

[Additional authority for this permit condition is derived from 40 CFR Part 60 Section 60.48c]

(a) The permittee shall maintain records of the following operating parameters for Source ID 040:

- (1) The amount of natural gas burned on a daily basis.
- (2) Calculations used to verify compliance with the CO, VOC, NO_x, and SO₂ emissions limitations.
- (3) SO₂, NO_x, CO, and VOC emissions calculations on a monthly basis to verify compliance with the 12 consecutive month emissions limitations.

(b) These records shall be made available to the Department upon request and shall remain on file for five years.

V. REPORTING REQUIREMENTS.**# 009 [25 Pa. Code §127.441]****Operating permit terms and conditions.**

(a) The permittee shall submit to the Department on a semiannual basis records of the following operating parameters for Source ID 040:

(1) NO_x, SO_x, CO and VOC emission calculations on a monthly basis used to verify compliance with the annual emissions limitations.

(b) All semiannual reports shall be submitted to the Department by September 1 for the preceding period January to June and March 1 for the preceding period July to December.

010 [40 CFR Part 60 Standards of Performance for New Stationary Sources §40 CFR 60.4]**Subpart A - General Provisions****Address.**

**SECTION D. Source Level Requirements**

The submission of all requests, reports, applications, submittals and other communications required by 40 CFR Part 60 Subpart Dc Sections 60.40c - 60.48c must be made to both the Department of Environmental Protection and the Environmental Protection Agency. The Environmental Protection Agency copies may be sent to:

Director
Air Enforcement Branch (3AP12)
U.S. EPA, Region III
1650 Arch Street
Philadelphia, PA 19103-2029

VI. WORK PRACTICE REQUIREMENTS.

No additional work practice requirements exist except as provided in other sections of this permit including Section B (State Only General Requirements).

VII. ADDITIONAL REQUIREMENTS.**# 011 [25 Pa. Code §127.441]****Operating permit terms and conditions.**

Source ID 040 is a Nebraska Boiler Company, model NS-E-63-ECON, 96.8 million BTU per hour natural gas boiler located in the Main Plant Boiler House. The air contaminant emissions from Source ID 040 shall be controlled by a low NOx burner and flue gas recirculation.

012 [25 Pa. Code §127.441]**Operating permit terms and conditions.**

[Additional authority for this permit condition is derived from 40 CFR 60.40c - 60.48c]

Source ID 040 is subject to 40 CFR Part 60 Subpart Dc Sections 60.40c - 60.48c of the Federal Standards of Performance for New Stationary Sources. The permittee shall comply with all applicable requirements of this subpart including any recordkeeping and reporting requirements.

013 [40 CFR Part 63 NESHAPS for Source Categories §40 CFR 63.11195]**SUBPART JJJJJJ - National Emission Standards for Hazardous Air Pollutants for Industrial, Commercial, and Institutional Boilers Area Sources****Are any boilers not subject to this subpart?**

Source ID 040 is not subject to 40 CFR Part 63 Subpart JJJJJJ, National Emission Standards for Hazardous Air Pollutants for Industrial, Commercial, and Institutional Boilers Area Sources, because it is a gas fired unit as defined by 40 CFR part 63 Section 63.11237.

**SECTION D. Source Level Requirements**

Source ID: 043

Source Name: 37 COMBUSTION SOURCES

Source Capacity/Throughput:

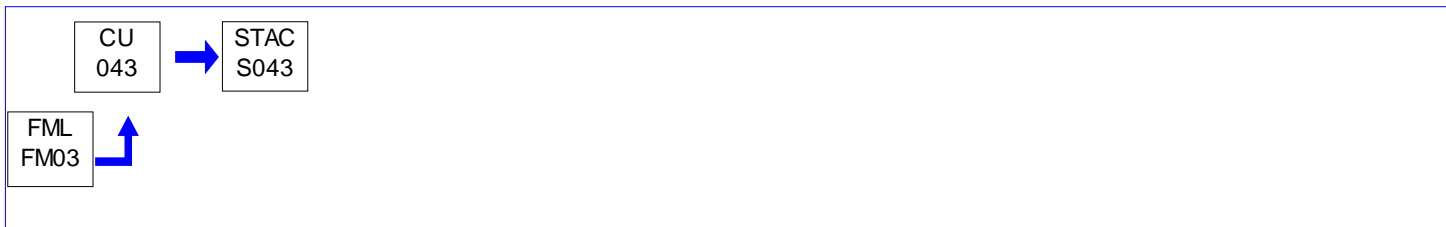
**I. RESTRICTIONS.****Emission Restriction(s).**

001 [25 Pa. Code §123.22]

Combustion units

[Compliance with the requirement specified in this streamlined permit condition assures compliance with the provision in 40 CFR 52.2020(c)]

No person may permit the emission into the outdoor atmosphere of Sulfur Oxides (SO_x), expressed as SO₂, from any combustion source of Source ID 043 in excess of the rate of 4 pounds per million Btu of heat input over any 1-hour period in accordance with 25 Pa. Code Section 123.22(a)(1).

Fuel Restriction(s).

002 [25 Pa. Code §127.441]

Operating permit terms and conditions.

Each unit of Source ID 043 shall only be fired on gas (natural or LP).

II. TESTING REQUIREMENTS.

No additional testing requirements exist except as provided in other sections of this permit including Section B (State Only General Requirements).

III. MONITORING REQUIREMENTS.

No additional monitoring requirements exist except as provided in other sections of this permit including Section B (State Only General Requirements).

IV. RECORDKEEPING REQUIREMENTS.

No additional record keeping requirements exist except as provided in other sections of this permit including Section B (State Only General Requirements).

V. REPORTING REQUIREMENTS.

No additional reporting requirements exist except as provided in other sections of this permit including Section B (State Only General Requirements).

VI. WORK PRACTICE REQUIREMENTS.

003 [25 Pa. Code §129.93]

Presumptive RACT emission limitations

Each unit of Source ID 043 shall be maintained and operated in accordance with manufacturer's specifications as well as in accordance with good air pollution control practices.

**SECTION D. Source Level Requirements****VII. ADDITIONAL REQUIREMENTS.****# 004 [25 Pa. Code §127.441]****Operating permit terms and conditions.**

Source ID 043 consists of 37 small (less than 2.5 million Btu/hr) natural gas-fired sources identified as follows:

26 Main Plant, Space Heaters, < or = 0.2 MMBtu/hr

7 Main Plant, King Makeup Air Units, 1.0 MMBtu/hr

2 Main Plant, Trane AC/Heat Units, 0.12 MMBtu/hr

1 Main Plant, Trane AC/Heat Unit (Print Shop), 0.35 MMBtu/hr

1 Main Plant, Air Handling Unit 0.350 MMBtu/hr

005 [40 CFR Part 63 NESHAPS for Source Categories §40 CFR 63.11195]**SUBPART JJJJJJ - National Emission Standards for Hazardous Air Pollutants for Industrial, Commercial, and Institutional Boilers Area Sources****Are any boilers not subject to this subpart?**

Source ID 043 is not subject to 40 CFR Part 63 Subpart JJJJJJ, National Emission Standards for Hazardous Air Pollutants for Industrial, Commercial, and Institutional Boilers Area Sources, because it is a gas fired unit as defined by 40 CFR part 63 Section 63.11237.

**SECTION D. Source Level Requirements**

Source ID: 044

Source Name: 7 AIR MAKEUP UNITS

Source Capacity/Throughput:

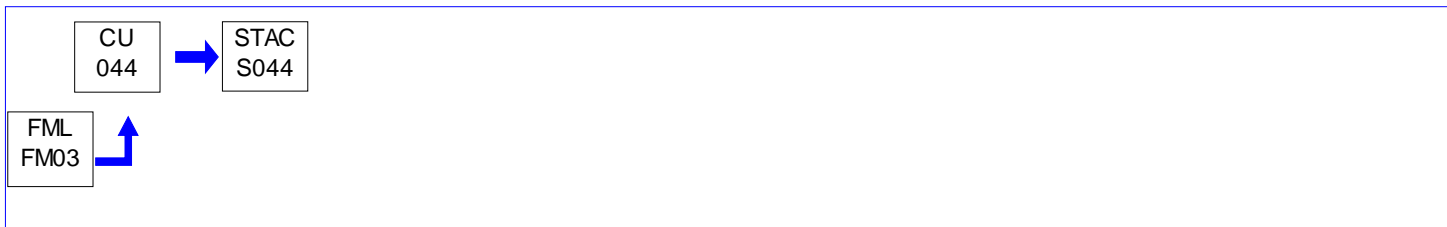
**I. RESTRICTIONS.****Emission Restriction(s).****# 001 [25 Pa. Code §123.11]****Combustion units**

No person may permit the emission of particulate matter from any combustion source of Source ID 044 into the outdoor atmosphere in excess of the rate of 0.4 pounds per million Btu of heat input in accordance with 25 Pa. Code Section 123.11(a)(1).

002 [25 Pa. Code §123.22]**Combustion units**

[Compliance with the requirement specified in this streamlined permit condition assures compliance with the provision in 40 CFR 52.2020(c)]

No person may permit the emission into the outdoor atmosphere of sulfur oxides, expressed as SO₂, from any combustion source of Source ID 044 in excess of the rate of 4 pounds per million Btu of heat input over any 1-hour period in accordance with 25 Pa. Code Section 123.22(a)(1).

Fuel Restriction(s).**# 003 [25 Pa. Code §127.441]****Operating permit terms and conditions.**

Source ID 044 shall only be fired on gas (natural or LP).

II. TESTING REQUIREMENTS.

No additional testing requirements exist except as provided in other sections of this permit including Section B (State Only General Requirements).

III. MONITORING REQUIREMENTS.

No additional monitoring requirements exist except as provided in other sections of this permit including Section B (State Only General Requirements).

IV. RECORDKEEPING REQUIREMENTS.

No additional record keeping requirements exist except as provided in other sections of this permit including Section B (State Only General Requirements).

V. REPORTING REQUIREMENTS.

No additional reporting requirements exist except as provided in other sections of this permit including Section B (State Only General Requirements).

**SECTION D. Source Level Requirements****VI. WORK PRACTICE REQUIREMENTS.****# 004 [25 Pa. Code §129.93]****Presumptive RACT emission limitations**

Each unit of Source ID 044 shall be maintained and operated in accordance with manufacturer's specifications as well as in accordance with good air pollution control practices.

VII. ADDITIONAL REQUIREMENTS.**# 005 [25 Pa. Code §127.441]****Operating permit terms and conditions.**

Source ID 044 consists of seven (7) natural gas-fired combustion sources identified as follows:

4 natural gas/propane fired Main Plant, Hastings makeup air units rated at 4.52 MMBtu/hr each.

1 natural gas/propane fired Microwave Label Line air handling unit rated at 1.5 MMBTU/hr.

2 natural gas fired Air Makeup Units at the main plant each rated at 4.66 MMBtu/hr.

**SECTION D. Source Level Requirements**

Source ID: P124

Source Name: SPAGHETTI EXTRUSION HOPPER 2

Source Capacity/Throughput:

**I. RESTRICTIONS.****Emission Restriction(s).**

001 [25 Pa. Code §123.13]

Processes

No person may permit the emission of particulate matter from the exhaust of ID C124B associated with Source ID P124 into the outdoor atmosphere in excess of 0.04 grains per dry standard cubic foot.

II. TESTING REQUIREMENTS.

No additional testing requirements exist except as provided in other sections of this permit including Section B (State Only General Requirements).

III. MONITORING REQUIREMENTS.

No additional monitoring requirements exist except as provided in other sections of this permit including Section B (State Only General Requirements).

IV. RECORDKEEPING REQUIREMENTS.

002 [25 Pa. Code §127.441]

Operating permit terms and conditions.

The permittee shall keep records of calculations used to verify compliance with the particulate matter emission limitation of 25 Pa. Code Sections 123.13. These records shall be retained for a minimum of five years and be shown to the Department upon request.

V. REPORTING REQUIREMENTS.

No additional reporting requirements exist except as provided in other sections of this permit including Section B (State Only General Requirements).

VI. WORK PRACTICE REQUIREMENTS.

003 [25 Pa. Code §127.441]

Operating permit terms and conditions.

The permittee shall keep on hand a sufficient quantity of spare fabric collector bags for the fabric collector (ID C124B) associated with Source ID P124 in order to be able to immediately replace any bag requiring replacement.

VII. ADDITIONAL REQUIREMENTS.

004 [25 Pa. Code §127.441]

Operating permit terms and conditions.

Source ID P124 is a Spaghetti Direct Extrusion Hopper (#2). The air contaminant emissions from Spaghetti Direct Extrusion Hopper #2 shall be controlled by a MAC model 93-AVRF-07-014. baghouse (ID C124B).

**SECTION D. Source Level Requirements**

Source ID: P131

Source Name: WASTEWATER TREATMENT PLANT

Source Capacity/Throughput:

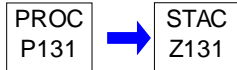
**I. RESTRICTIONS.**

No additional requirements exist except as provided in other sections of this permit including Section B (State Only General Requirements).

II. TESTING REQUIREMENTS.

No additional testing requirements exist except as provided in other sections of this permit including Section B (State Only General Requirements).

III. MONITORING REQUIREMENTS.

No additional monitoring requirements exist except as provided in other sections of this permit including Section B (State Only General Requirements).

IV. RECORDKEEPING REQUIREMENTS.

No additional record keeping requirements exist except as provided in other sections of this permit including Section B (State Only General Requirements).

V. REPORTING REQUIREMENTS.

No additional reporting requirements exist except as provided in other sections of this permit including Section B (State Only General Requirements).

VI. WORK PRACTICE REQUIREMENTS.

No additional work practice requirements exist except as provided in other sections of this permit including Section B (State Only General Requirements).

VII. ADDITIONAL REQUIREMENTS.

001 [25 Pa. Code §127.441]

Operating permit terms and conditions.

Source ID P131 is the wastewater pretreatment facility.

**SECTION D. Source Level Requirements**

Source ID: P141

Source Name: SIX STORAGE SILOS

Source Capacity/Throughput:

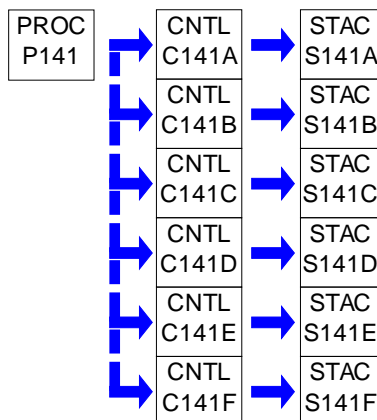
**I. RESTRICTIONS.****Emission Restriction(s).****# 001 [25 Pa. Code §127.441]****Operating permit terms and conditions.**

[Compliance with this operating permit condition assures compliance with the provisions of 25 Pa. Code Section 123.13][Additional authority for this operating permit condition is also derived from 25 Pa. Code Sections 127.1 and 127.12]

The particulate matter emissions in the exhaust of each fabric collector associated with Source ID P141 shall not exceed 0.003 grains per dry standard cubic foot.

002 [25 Pa. Code §127.441]**Operating permit terms and conditions.**

[Compliance with this operating permit condition assures compliance with the provisions of 25 Pa. Code Section 123.41][Additional authority for this operating permit condition is also derived from 25 Pa. Code Sections 127.1 and 127.12]

There shall be no visible emissions in the exhaust of the fabric collectors associated with Source ID P141.

II. TESTING REQUIREMENTS.

No additional testing requirements exist except as provided in other sections of this permit including Section B (State Only General Requirements).

III. MONITORING REQUIREMENTS.**# 003 [25 Pa. Code §127.441]****Operating permit terms and conditions.**

[Additional authority for this operating permit condition is also derived from 25 Pa. Code Sections 127.1 and 127.12]

Each fabric collector associated with the silos of Source ID P141 shall be equipped with instrumentation that continuously monitors the pressure drop across the collectors.

IV. RECORDKEEPING REQUIREMENTS.**# 004 [25 Pa. Code §127.441]****Operating permit terms and conditions.**

The permittee shall record the pressure drops across each of the fabric collectors at least once per day. Additionally, the permittee shall keep records which verify compliance with the particulate matter emission limitation applicable to Source ID

**SECTION D. Source Level Requirements**

P141. The permittee shall keep these records for a minimum of five years and the records shall be presented to the Department upon request.

V. REPORTING REQUIREMENTS.

No additional reporting requirements exist except as provided in other sections of this permit including Section B (State Only General Requirements).

VI. WORK PRACTICE REQUIREMENTS.

005 [25 Pa. Code §127.441]

Operating permit terms and conditions.

[Additional authority for this operating permit condition is also derived from 25 Pa. Code Sections 127.1 and 127.12]

The permittee shall keep on hand a sufficient quantity of spare fabric collector bags for Control Device IDs C141A – C141F associated with Source P141 in order to be able to immediately replace any bag that requires replacement.

VII. ADDITIONAL REQUIREMENTS.

006 [25 Pa. Code §127.441]

Operating permit terms and conditions.

Pursuant to the best available technology requirements of 25 Pa. Code Sections 127.1 and 127.12, Source ID P141 consists of six (6) 225,000 pound capacity storage silos used to store hard wheat and semolina. Each storage silo shall have the particulate matter emissions controlled by its own dedicated MAC model 39AVSC25 fabric collector (IDs C141A, C141B, C141C, C141D, C141E and C141F).

**SECTION D. Source Level Requirements**

Source ID: P145

Source Name: COLD CLEANING MACHINES

Source Capacity/Throughput:

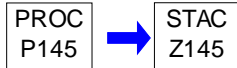
**I. RESTRICTIONS.**

No additional requirements exist except as provided in other sections of this permit including Section B (State Only General Requirements).

II. TESTING REQUIREMENTS.

No additional testing requirements exist except as provided in other sections of this permit including Section B (State Only General Requirements).

III. MONITORING REQUIREMENTS.

No additional monitoring requirements exist except as provided in other sections of this permit including Section B (State Only General Requirements).

IV. RECORDKEEPING REQUIREMENTS.**# 001 [25 Pa. Code §127.441]****Operating permit terms and conditions.**

(a) The permittee shall keep comprehensive and accurate records of the the amount of cleaning solvent used in Source ID P145 in each month.

(b) These records shall be retained for a minimum of 5 (five) years and shall be made available to the Department upon request.

002 [25 Pa. Code §129.63]**Degreasing operations**

The permittee shall keep records for a minimum of five years and present to the Department upon request the following information:

- (1) The name and address of the solvent supplier,
- (2) The type of solvent including the product or vendor identification number,
- (3) The vapor pressure of the solvent measured in mm of Hg at 68 degrees F.

V. REPORTING REQUIREMENTS.

No additional reporting requirements exist except as provided in other sections of this permit including Section B (State Only General Requirements).

VI. WORK PRACTICE REQUIREMENTS.**# 003 [25 Pa. Code §129.63]****Degreasing operations**

- (1) The immersion cold cleaning machine of Source ID P145 shall have freeboard ratio of greater than 0.50.
- (2) All units of Source ID P145 shall have a permanent conspicuous label summarizing these operating requirements:

**SECTION D. Source Level Requirements**

-Waste solvent shall be collected and stored in a closed container. The closed container may contain a device that allows pressure relief, but does not allow liquid solvent to drip from the container.

-Flushing of Parts using a flexible hose or other flushing device shall be performed only within the cold cleaning machine. The solvent spray shall be a solid fluid stream, not an atomized or shower spray.

-Sponges, fabric, wood, leather, paper products, and other absorbent materials may not be cleaned in the cold cleaning machine.

-Air agitated solvent baths may not be used.

-Spills during solvent transfer and use of cold cleaning machine shall be cleaned up immediately.

The label shall include the following discretionary good operating practices:

(a) Cleaned parts should be drained at least 15 seconds or until dripping ceases, whichever is longer. Parts having cavities or blind holes shall be tipped or rotated while the part is draining.

(b) During the draining, tipping or rotating, the parts should be positioned so that solvent drains directly back to the cold cleaning machine.

(c) Work area fans should be located and positioned so that they do not blow across the opening of the degreaser unit.

(3) Equipped with a cover that shall be closed at all times except during the cleaning of parts or the addition or removal of solvent.

VII. ADDITIONAL REQUIREMENTS.**# 004 [25 Pa. Code §127.441]****Operating permit terms and conditions.**

Source ID P145 consists of the following four parts washers:

(a) Three (3) Certified Brand 30 gallon capacity cleaning machines.

(b) One (1) Safety Kleen 16 gallon capacity immersion cleaning machine.

005 [25 Pa. Code §129.63]**Degreasing operations**

A person may not use or sell for use in a cold cleaning machine any solvent with a vapor pressure of 1.0 millimeter of mercury or greater and containing greater than 5% VOC by weight, measured at 68 degrees F containing VOCs.

**SECTION D. Source Level Requirements**

Source ID: P148

Source Name: DIESEL FIRE PUMP

Source Capacity/Throughput:

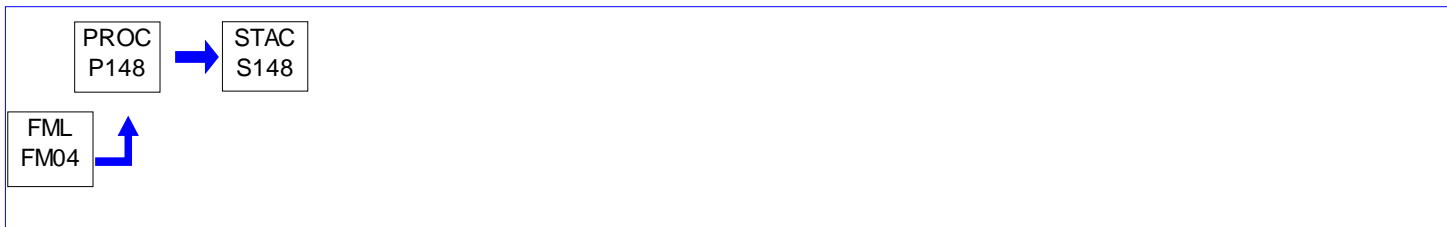
**I. RESTRICTIONS.****Emission Restriction(s).**

001 [40 CFR Part 60 Standards of Performance for New Stationary Sources §40 CFR 60.4205]
Subpart IIII - Standards of Performance for Stationary Compression Ignition Internal Combustion Engines
What emission standards must I meet for emergency engines if I am an owner or operator of a stationary CI internal co

[Compliance with this streamlined permit condition also assures compliance with the provisions of 25 Pa. Code Section 123.13][Additional authority for this permit requirement is also derived from 40 CFR Part 60 Section 60.4211]

The emissions from Source ID P148 shall not exceed the following rates:

NO_x + NMOC - 7.8 grams/hp-hr

CO - 3.7 grams/hp-hr

PM - 0.6 grams/hp-hr

Fuel Restriction(s).

002 [40 CFR Part 60 Standards of Performance for New Stationary Sources §40 CFR 60.4207]
Subpart IIII - Standards of Performance for Stationary Compression Ignition Internal Combustion Engines
What fuel requirements must I meet if I am an owner or operator of a stationary CI internal combustion engine subject to

[Compliance with this streamlined permit requirement assures compliance with the provisions of 25 Pa. Code Section 123.21 and 40 CFR Part 80 Section 80.510(c)]

All NRLM diesel fuel is subject to the following per-gallon standards:

(1) Sulfur content. 15 ppm maximum.

(2) Cetane index or aromatic content, as follows:

(i) A minimum cetane index of 40; or

(ii) A maximum aromatic content of 35 volume percent.

Operation Hours Restriction(s).

003 [25 Pa. Code §127.441]
Operating permit terms and conditions.

Source ID P148 shall not be operated in excess of 500 hours in any 12 consecutive month period.

II. TESTING REQUIREMENTS.

No additional testing requirements exist except as provided in other sections of this permit including Section B (State Only General Requirements).

**SECTION D. Source Level Requirements****III. MONITORING REQUIREMENTS.**

No additional monitoring requirements exist except as provided in other sections of this permit including Section B (State Only General Requirements).

IV. RECORDKEEPING REQUIREMENTS.

004 [25 Pa. Code §127.441]

Operating permit terms and conditions.

The permittee shall maintain records of the number of hours the fire pump is operated each month and the corresponding 12 consecutive month totals. These records shall be retained for a minimum of five years and be presented to the Department upon request.

V. REPORTING REQUIREMENTS.

No additional reporting requirements exist except as provided in other sections of this permit including Section B (State Only General Requirements).

VI. WORK PRACTICE REQUIREMENTS.

No additional work practice requirements exist except as provided in other sections of this permit including Section B (State Only General Requirements).

VII. ADDITIONAL REQUIREMENTS.

005 [25 Pa. Code §127.441]

Operating permit terms and conditions.

Source ID P148 is a Cummins model CFP59-F40 diesel fire pump rated at 171 bhp.

006 [40 CFR Part 60 Standards of Performance for New Stationary Sources §40 CFR 60.4200]

Subpart IIII - Standards of Performance for Stationary Compression Ignition Internal Combustion Engines**Am I subject to this subpart?**

Source ID P148 is subject to 40 CFR Part 60 Subpart IIII, Standards of Performance for Stationary Compression Ignition Internal Combustion Engines, Sections 60.4200 - 60.4219. The permittee shall comply with all applicable requirements of this subpart.



SECTION E. Source Group Restrictions.

**SECTION F. Alternative Operation Requirements.**

No Alternative Operations exist for this State Only facility.

**SECTION G. Emission Restriction Summary.**

Source Id	Source Descriptor		
036	BOILER 6		
Emission Limit			
0.100	Lbs/MMBTU	when firing nat. gas	NOX
4.000	Lbs/MMBTU	over any 1-hour period	SOX
0.400	Lbs/MMBTU	when heat input is < 50 MMBTU/hr	TSP
039	BOILER 7		
Emission Limit			
0.100	Lbs/MMBTU	when firing nat. gas	NOX
4.000	Lbs/MMBTU	over any 1-hour period	SOX
0.400	Lbs/MMBTU	when heat input is < 50 MMBTU/hr	TSP
040	BOILER 8		
Emission Limit			
0.100	Lbs/MMBTU		CO
42.400	Tons/Yr	in any 12 CMP	CO
0.040	Lbs/MMBTU	when firing nat. gas	NOX
24.400	Tons/Yr	in any 12 CMP	NOX
4.000	Lbs/MMBTU	over any 1-hour period	SOX
0.400	Lbs/MMBTU	when firing rate < 50 MMBTU/hr	TSP
0.005	Lbs/MMBTU		VOC
2.120	Tons/Yr	in any 12 CMP	VOC
043	37 COMBUSTION SOURCES		
Emission Limit			
4.000	Lbs/MMBTU	over any 1-hour period	SOX
044	7 AIR MAKEUP UNITS		
Emission Limit			
0.400	Lbs/MMBTU		PM10
4.000	Lbs/MMBTU		SOX
P124	SPAGHETTI EXTRUSION HOPPER 2		
Emission Limit			
0.040	gr/DRY FT3		PM10
P141	SIX STORAGE SILOS		
Emission Limit			
0.003	gr/DRY FT3		TSP
P148	DIESEL FIRE PUMP		
Emission Limit			
3.700	GRAMS/HP-Hr		CO
7.800	GRAMS/HP-Hr	limit is NOx + NMHC	NOX
0.600	GRAMS/HP-Hr		TSP



SECTION G. Emission Restriction Summary.

Site Emission Restriction Summary

Emission Limit	Pollutant
----------------	-----------



SECTION H. Miscellaneous.

The following air contaminant sources are considered to be of minor significance to the Department and have been determined to be exempt from permit requirements. However, this determination does not exempt the sources from compliance with all applicable air quality regulations specified in 25 Pa. Code Chapters 121-145:

- (1) Ink usage and Glue usage
- (2) Laboratory Fume Hoods
- (3) Pesticide Applications
- (4) One Flour Hopper servicing Ravioli Lines A, B, & C controlled by a baghouse the exhaust internally.
- (5) One transfer hopper and hopper assembly controlled by a baghouse and exhausts internally.
- (6) Four exhaust fans associated with the label application station.
- (7) Wastewater Engine (G1)
- (8) Emergency Engine (G2)
- (9) Four (4) dust collectors that exhaust internally.



***** End of Report *****
